

## Contents & Specification

### AR-401RO16B

**1 Product**



**2 User guide**

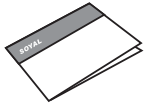

**3 Specification**

- Communication: RS-485
- Baud rate: 4800bps/9600bps/19200bps(N, 8, 1)
- Channels: 1. 16 Form C Relay Output  
2. N.O./N.C. select via Jumper  
3. 16 COM. were dispatched 16 Relay
- Power Supply: +9 ~ +24VC
- Contact Rating: AC: 110V@0.6A DC: 24V@2A
- LED indicator: Power, Tx/Rx, Relay On/Off
- Dimension(mm): 180(L) x 231(W) x 62(H)
- Weight(g): 1,780±10g
- Housing Material: Metal

## AR-401DI16 Node ID Setting

### BAUD4800 for Elevator Control

#### SW1-4: Node ID Selection



Apply to

AR-721H/ AR-321H/  
AR-725H/ AR-727H/  
AR-327H/ AR-757H/  
AR-821EF/AR-829E

#### Node 1~16 ID# 1~16

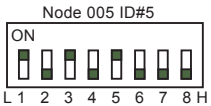
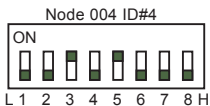
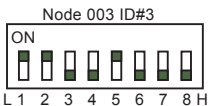

ID	#1	#2	#4	#5
Floor Mapping	1~16	17~32	33~48	49~64
User Number decode output by binary	#3			

### BAUD9600

#### SW1-4: Node ID Selection



Apply to

AR-725E

#### Node 1~16 ID# 1~16

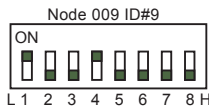
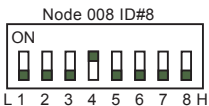
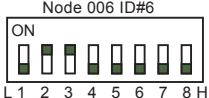

### BAUD19200

#### SW1-5: Node ID Selection

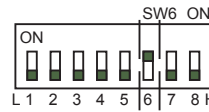

#### Node 1~32 ID# 1~32

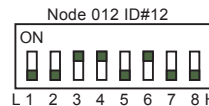

#### N.C./N.O. Type switch

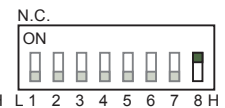
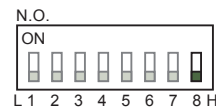

## Diagram

### A. BAUD 4800

#### 1. AR-829E

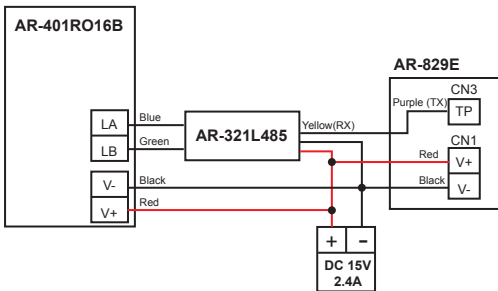

#### 2. AR-821EF

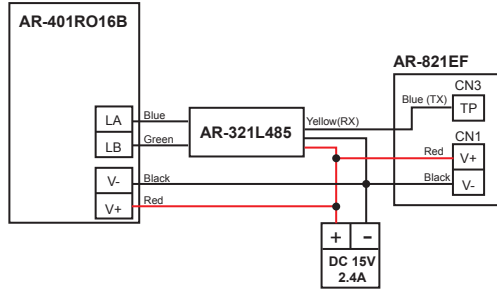

#### 3. AR-321H/AR-721H/AR-725H

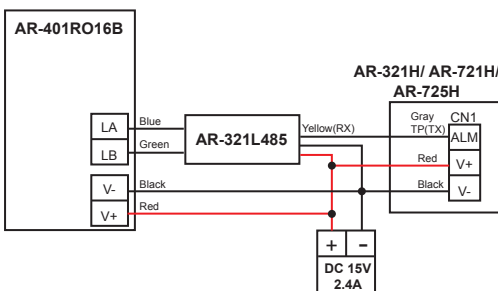

#### 4. AR-327H/AR-727H

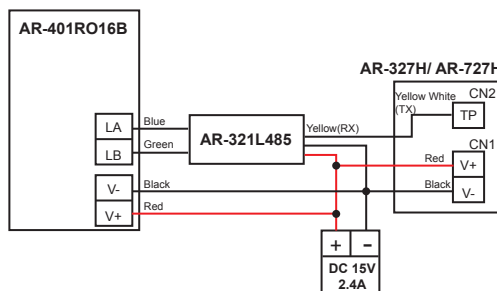

### B. BAUD 9600

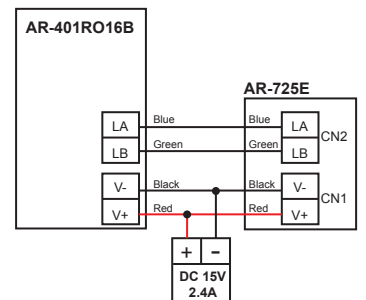

## Diagram of AR-401RO16B and Push button of Elevator

- Diagram of lift button to AR-401RO16B (non-common point) :

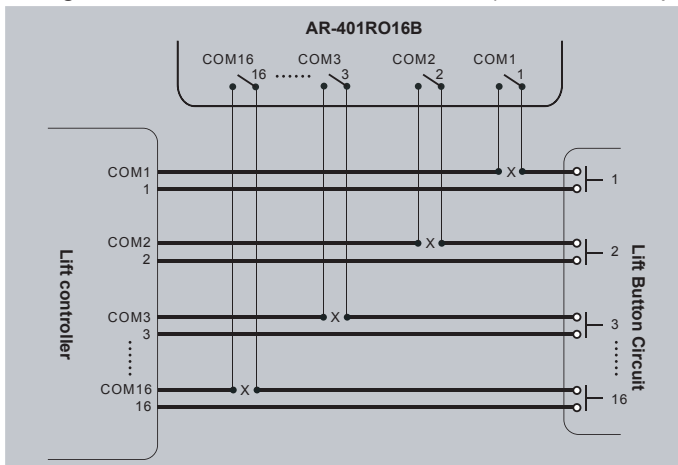

— P.S. —

If AR-401RO16B is set to be a NC (Normal Close) device, its entire relay will stay close when power is turned down. In this case, the lift is not under the control of AR-401RO16B.

- Diagram of lift button to AR-401RO16B (common point) :

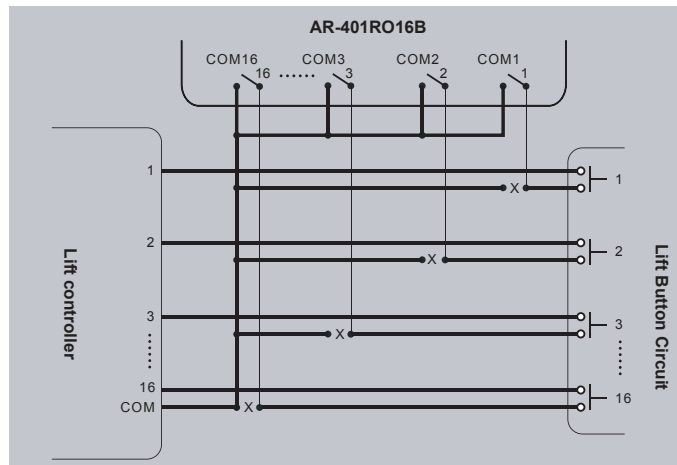
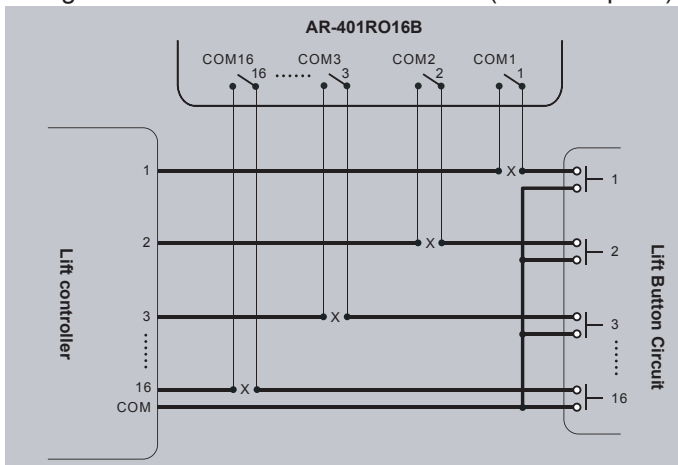

• COM-point links, respectively point link

• COM-point after the common-COM-point serial link

- There are 16 Relay Output. 16 COM were dispatched to 16 Relay separately.

- Diagram of lift button to AR-401RO16B:

When used for lift control, BAUD should be set to 4800bps and DIP SW5 switched to ON. DIP SW1~4 is used for setting AR-401RO16B Node ID. It will be binary decoded output when Node ID is set to 3; and it is usually used for auto control condition, such as parking equipment. (Node ID #1, #2, #4, #5 are used for lift)

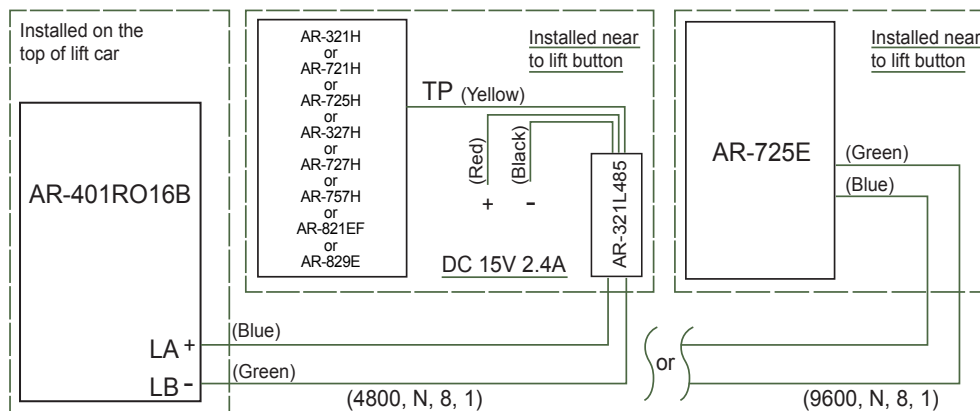
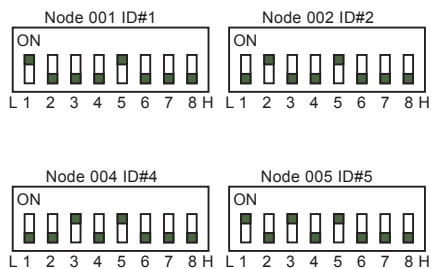

**SOYAL** <http://www.soyal.com>

- During install of AR-401RO16B, the engineer from the lift company is needed.
- To have more detailed information, E-learning, and Q&A, please visits our website.

Thanks for You